

# megaSun<sup>®</sup>

by KBL



megaSun<sup>®</sup> Tower pureEnergy

## Operating Instructions





# Copyright and Trademark

© Copyright 2013 KBL AG

This documentation only covers products manufactured by KBL AG. It must not be duplicated, photocopied, translated or stored without prior specific permission by KBL AG. Duplication on electronic media or in machine-readable form, either in whole or in part, is also prohibited.

 is a registered trademark of KBL AG.

## DISCLAIMER

All information given in this document correspond to the status quo at the date of publication but may be subject to changes. Therefore, we do not accept any liability for, nor do we guarantee the accuracy and/or completeness of the information.

Technical equipment and versions of the devices are in accordance with the legal prescriptions of the respective country of destination. Export to the USA and Canada of the KBL products, listed in this guide, or operation of the systems in these countries, are not permitted. KBL does not accept any manufacturers liability in case this direction is not adhered to. It is expressly pointed out that any violation of the export/operation prohibition will involve substantial risks of liability for the exporter and/or operator.

Version: BA\_TpureEnergy\_GB\_E

Date: 08/2013

Item no.: 0100036150

For instruction updates, please refer to <http://www.kbl-support.de>.

KBL AG

Ringstrasse 24-26 · 56307 Dernbach · Germany

Telephone +49(0)2689.9426-0 · Fax +49(0)2689.9426-66

Email: [megaSun@kbl.de](mailto:megaSun@kbl.de)

**[www.megaSun.de](http://www.megaSun.de)**

# Contents

<b>General information</b> .....	<b>5</b>	Overview: KBL5 service menu .....	21
About these instructions .....	5	Overview: KBL4 service menu .....	22
Transport by forklift truck .....	5	Information about operation .....	25
Other modes of transport.....	5	Displaying the operating hours of the solarium .....	25
Old equipment disposal .....	5	Displaying the operating hours of the tubes .....	25
Service.....	5	Temperature display A/B .....	25
<hr/>		Resetting the operating hours of the tubes .....	25
<b>Safety notes</b> .....	<b>6</b>	Setting the timer function of the dec. lighting .....	25
Intended use.....	6	Setting date and time .....	26
Duties of the operator .....	6	Entering PIN II .....	26
Timer operation .....	6	Setting aquaCool characteristics .....	26
Wearing a hair net.....	6	Setting the audio music system .....	27
General safety advice.....	7	STANDARD AUDIO SOURCE .....	27
Tanning times .....	7	Basic settings audio system .....	28
<hr/>		Setting the operating hours of the tubes .....	28
<b>Description of the unit</b> .....	<b>8</b>	Download information .....	28
Standards .....	8	Basic settings aquaCool .....	28
Functionality .....	8	aquaCool tests .....	28
Components.....	8	Querying software information .....	29
Operation using different audio sources .....	10	Setting the easyCare unit .....	29
<hr/>		Entering PIN III .....	30
<b>Connections</b> .....	<b>11</b>	<hr/>	
Connecting the mains voltage.....	11	<b>Maintenance and cleaning</b> .....	<b>31</b>
Connecting an external audio source .....	11	Instructions for cleaning and care .....	31
Connecting the external timer .....	12	Maintenance intervals .....	31
Connecting the channel selection.....	12	Removing and installing the acrylic panes.....	32
Connectors on the aquaCool box .....	12	Cleaning and replacing the tubes.....	33
<hr/>		Changing the SD card in the MP3 player.....	35
<b>Start-up</b> .....	<b>13</b>	Recording to an SD card.....	36
Operating modes.....	13	Replacing the aquaCool canister .....	36
<hr/>		<hr/>	
<b>Tanning instructions</b> .....	<b>14</b>	<b>Error messages</b> .....	<b>38</b>
Instructions for the user .....	14	<hr/>	
Tanning times .....	15	<b>Technical data</b> .....	<b>39</b>
<hr/>		Views .....	40
<b>Operation in tanning mode</b> .....	<b>16</b>	<hr/>	
Assuming the tanning position and			
starting / stopping the tanning session .....	18		
Adjusting the body fan .....	18		
Adjusting the volume (optional feature).....	18		
Selecting the audio source and track.....	18		
aquaCool (optional feature) .....	19		
megaVoice on/off (optional feature).....	19		
<hr/>			
<b>Standby/service mode</b> .....	<b>20</b>		
Turning the decorative lighting on and off.....	20		
Invoking the service menu.....	20		

# General information

## About these instructions

This operating manual is intended for use by

- operating staff,
- users,
- service staff.

Any person dealing with this tanning unit must have read and understood these instructions.

This manual describes units equipped with the maximum number of features.

Keep this manual ready to hand at all times.

## Transport by forklift truck

The device is mounted on a pallet.

- Insert the forks carefully into the openings of the pallet.
- Lift the load by a few centimetres.
- Transport the load carefully to the place of installation.

	<p><b>⚠ DANGER</b></p>
	<p><b>Overturning load!</b>  <b>Danger of being crushed by heavy parts of the equipment.</b></p> <ul style="list-style-type: none"> <li>• <b>Wear safety shoes.</b></li> </ul>

## Other modes of transport

If a forklift truck cannot be used for transport, the box must be unpacked and the parts inside must be transported individually to the place of installation, e.g. using a dolly. Depending on the weight of the components, lifting them might require several people.

## Old equipment disposal



This device consists of components that cannot be thrown into the household garbage!

Dispose of your old equipment in an environmentally friendly manner after the end of its useful life. Metals and plastics can be recycled. Electrical and electronic components must be disposed of as e-waste. Fluorescent lamps must be dropped off at authorized collection points for pollutants.

This helps to avoid damaging effects to the environment and human health caused by improper disposal.

This makes a valuable contribution to recycling and other forms of utilization of old electrical and electronic equipment.

You can obtain information about environmentally friendly disposal from your local government or the municipal administrations.

## Service

For all service-related questions, please contact your responsible specialist dealer.

# Safety notes

This chapter provides a summary of general information on safety and proper handling of the device. More specific safety advice is given in other chapters of the operating manual.

## Intended use

The unit is intended to be used for the tanning of one single person at a time. This person must not fall in one of the categories mentioned below, otherwise using the tanning equipment is prohibited for him or her.

The following individuals must not use the tanning system:

- Persons under 18 years of age
- Persons with heart pacemakers.
- Persons, who are suffering or have suffered from skin cancer or have a predisposition toward this, or those whose first-degree relatives are suffering or have suffered from malignant melanoma (black skin cancer).
- Persons taking photosensitive medications.
- Persons, who are being treated by a physician for conditions associated with photosensitivity.
- Persons suffering from acute sunburn.
- Persons, who are prone to freckles.
- Persons with atypical discoloured skin areas or/ and with more than five atypical moles with a diameter of 5 millimetres or more and persons with more than 16 moles with a diameter greater than or equal to 2 millimetres. If in doubt, consult a physician!
- Persons, who had several severe sunburns as children.
- Persons with naturally red skin colour.
- Persons, who do not tan at all or cannot tan without getting sunburn.

- Persons, who have a predisposition toward sunburn.

Furthermore, this tanning unit has been designed for use by individuals who are in full command of their physical, sensorial and mental faculties. Moreover, sufficient knowledge and experience are required. During the operation no other persons shall be in the radiation range of the device.

Children, should be supervised to make sure that they do not use the unit as a toy.

## Duties of the operator

KBL AG cannot be held liable for any damage resulting from improper use of the equipment or non-observance of these operating instructions.

Only use original replacement parts!

Only replace tubes and high pressure lamps with those listed on the device. Otherwise, this voids the operating authorization and warranty!

## Timer operation

The tanning unit must be controlled via an external timer. Should the external timer fail, an internal timer will switch off the system automatically after 30 minutes.

## Wearing a hair net

Studio clients with long hair must wear hair nets during tanning sessions to ensure safety.

## General safety advice

- Follow all instructions given in this manual. In addition, observe all relevant statutory provisions and regulations, also those applicable in the country of operation.
- The unit must only be installed and assembled by specifically trained staff.
- Arbitrary modifications or conversions of the equipment are not permissible.
- Observe all danger signs and safety notices attached to the equipment.
- Safety notices must not be removed, and safety equipment must not be disabled or removed.
- The unit must only be operated when in perfect working condition.
- Never operate the unit with the outer covers or acrylic panes removed.
- The tanning system must be controlled via a timer that complies with the generally applicable standards.
- Absolutely observe the maintenance frequencies indicated in the maintenance plan.

## Tanning times

Adhering to tanning times and schedules is essential.

# Description of the unit

## Standards



This tanning system complies with the following standards in their respectively applicable version:

- EN 60335-2-27
- Low Voltage Directive 2006/95/EC
- EMV 2004/108/EC

## Functionality

The "Tower pureEnergy" tanning unit (simply called "Tower" in the following) is intended for use for the tanning of one single adult person at a time; this person must have a skin type that tolerates tanning. The client is standing upright while tanning. Thanks to its vertical construction form, the unit can also be operated under limited space conditions.

The Tower (*figure 8.1*) can be of the circulating-air type or the exhaust-air type. For the circulating-air type, the purpose of the ceiling fan ⑤ is to cool down both the tubes and the client's body.

Equipped with the optionally available central exhaust-air module ⑥ (*figure 8.3*), the ceiling fan cools down the tubes.

Apart from this, the two operating modes differ from each other with regard to fan control and ceiling crown ④.

A tanning booth that has been optimised to suit the Tower dimensions is also available.

## Components

The Tower mainly consists of the following components:

- Base plate
- Two side parts, comprising 12 tubes each
- Rear part including 14 tubes, operating unit and control components
- Cabin door including 14 tubes
- Ceiling including fan
- Casing of central exhaust-air module (optional equipment)



**Tower pureEnergy, with door opened**

Figure 8.1



Figure 8.3

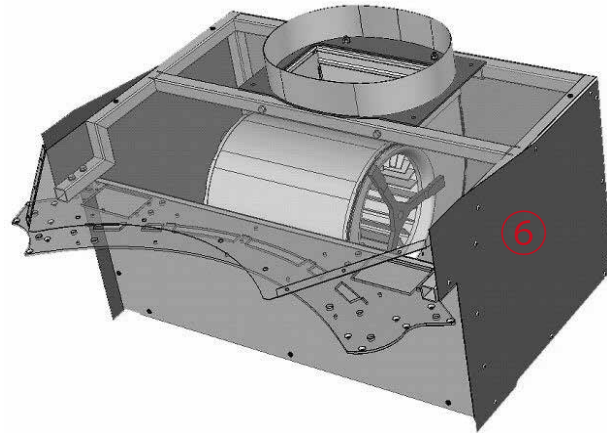

**Lateral view, with door opened**

Figure 8.4



**Top view, with door opened**

Figure 8.2

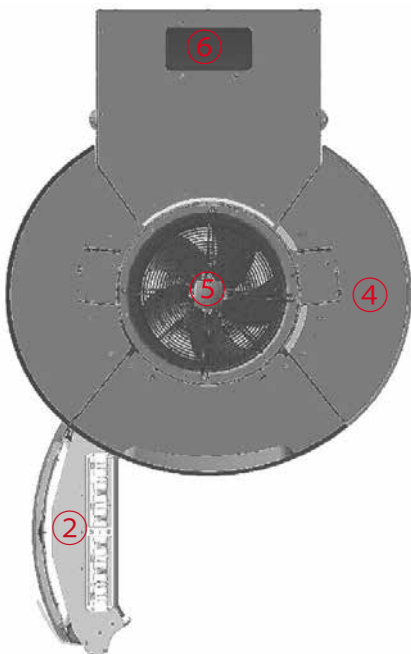

1	Side part
2	Cabin door
3	Base plate
4	Ceiling (rim crown)
5	Ceiling fan
6	Fan casing (central exhaust air)
7	Rear part

**Central exhaust-air module**

## Operation using different audio sources

The tanning unit can be operated using the following audio sources:

- An internal MP3 player
- An external audio source
- Both audio sources

Use the control panel to alternate between internal and external audio source.

### INTERNAL MP3 PLAYER

When using the internal MP3 player, you can either play the music that is originally supplied on the SD card, or you can record your own tracks to the card.

### EXTERNAL AUDIO SOURCE

As an external audio source, you can connect devices ranging from the standard-line level to a low loudspeaker level. The required level adjustment is performed via the potentiometer on the audio switch board.

You need to purchase the optionally available audio package in order to be able to operate the system with these audio sources.

For further information, please refer to the chapters “Connections” and “Operation in service mode”.

# Connections

## Connecting the mains voltage

**⚠ DANGER!**

**Live components**

Risk of fatal injury due to electric shock when touching live parts.

- **Switch off mains voltage.**
- **Protect against re-connection.**

Both the power supply and the related connection work must comply with national standards, e.g. those set up by VDE in Germany. The connection work must only be performed by qualified expert staff. The connection to the 400 V mains must be protected by fuses. Their specifications are listed in the chapter "Technical data".

A residual current-operated circuit breaker (RCD) with short time delay is absolutely required. KBL AG recommends the following type: KBL 3200 0770 00 (type (Typ ABB F 204 A - 40//0,03 AP-R)

Should the operation of the tanning unit cause any interference in the power supply network, e.g. with ripple-control systems (TRA), consult your power supply company to have corresponding blocking elements (audio frequency suppressors) installed.

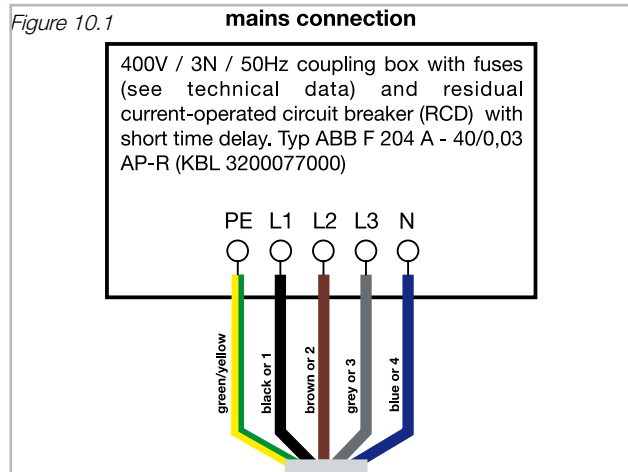

## Connecting an external audio source

When connecting an external audio source, pay attention to the correct polarity.

Figure 10.2

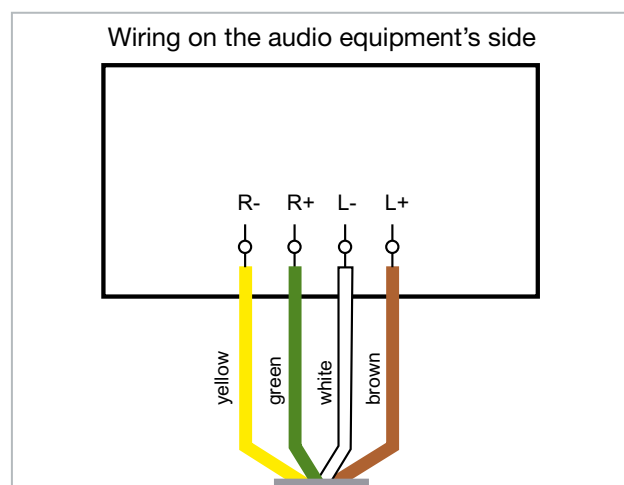

### LEVEL ADJUSTMENT

The voice/audio system components are installed in the rear wall of the Tower. Level adjustment is carried out via a potentiometer ① (figure 10.3) that is located on the audio switch circuit board.

Figure 10.3

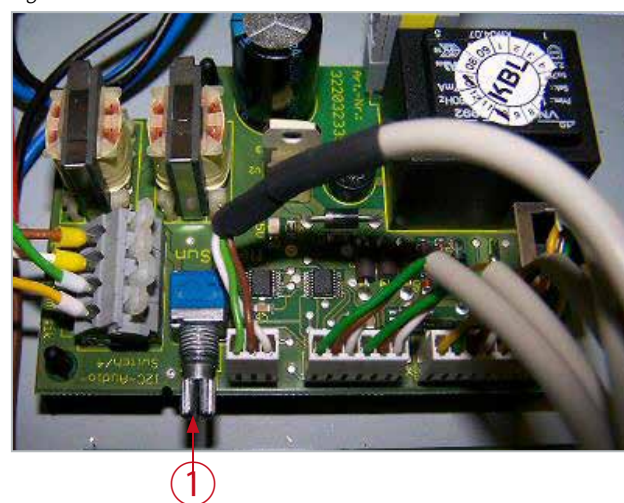

## Connecting the external timer

Connect the external timer (coin box, studio control) according to the instructions supplied with the timer. The following diagram shows the wiring requirements with regard to the timer. The door contact is required if you have opted for the booth-scenting feature.

Figure 11.1

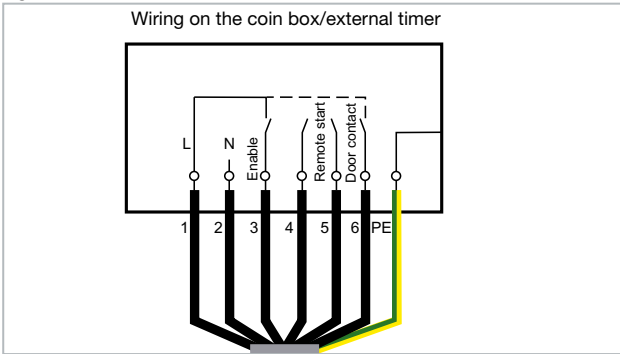

## Connecting the channel selection

The following diagrams show the wiring of the channel selection on the audio equipment's side, for pulse coding and for BCD coding.

Figure 11.2

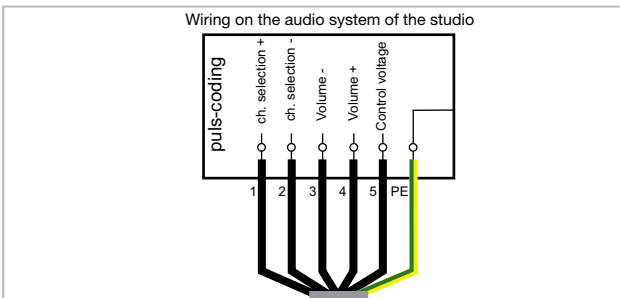
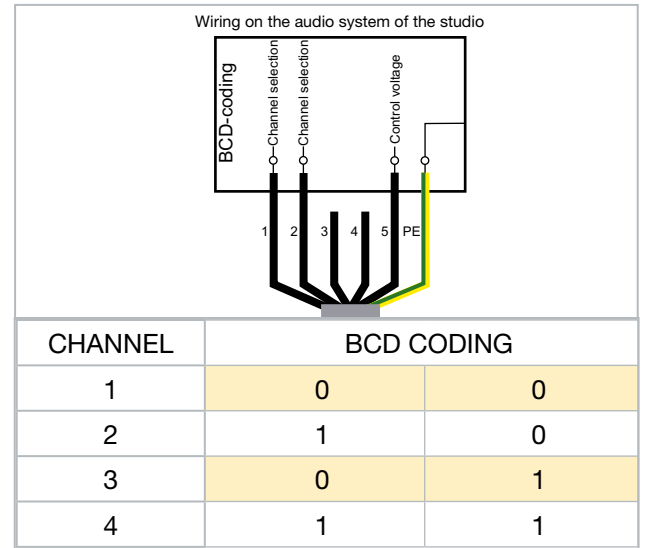

Figure 11.3



## Connectors on the aquaCool box

The aquaCool box is equipped with a connection for liquid-level monitoring ① as well as with a hose connection each for supply and return of the aquaCool liquid. The supply line ② is marked in green whereas the return line ③ is marked in red.

Figure 11.4

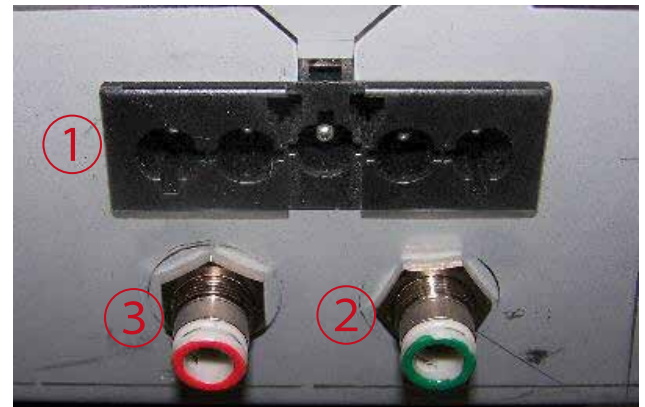

1	Connector (liquid-level monitoring)
2	Inlet (aquaCool medium)
3	Backflow (aquaCool medium)

# Start-up

Before switching on for the first time:

Fix the supplied warning sign or one with the following wording permanently to the wall close to the tanning unit:

**Warning!**

- UV-radiation can cause eye and skin damage as well as skin aging and possibly skin cancer. Ask the studio staff for further information.
- Wear protective goggles.
- Certain medicines or cosmetics can increase the sensitivity of the skin to UV radiation. If in doubt, consult a physician.

- Determine the presettings for the device in the service menu.
- Check correct installation of fluorescent tubes. The tube labeling must be visible, otherwise no tanning effect may be obtained.
- Store these Operating Instructions in a place that allows for easy access at any time.

## Operating modes

The three different operating modes are explained below:

### STANDBY MODE

The unit is in an idle state, i.e. it is connected to the mains but is currently not being used. The tubes are switched off. From the standby mode, you can change over to the tanning mode or to the service mode.

### TANNING MODE

The tubes are switched on and a tanning session is in progress. While the unit is in tanning mode, the settings for the ongoing tanning session can be changed via the control panel.

### SERVICE MODE

In the service mode, the device is configured for the tanning mode. Various values can be displayed and test functions can be carried out.

### FAN RUN-ON

After the tanning session, the fan runs on for 3 minutes in order to cool down the device. The fan power is automatically decreased as the tubes cool down.

# Tanning instructions

As a rule, an averagely tanning skin has achieved a uniform tan after three to five tanning sessions. These sessions should take place every second day. To preserve the suntan achieved, one or two tanning sessions per week are normally sufficient.

## Instructions for the user

Observe the following tanning instructions:

### NO SUNSCREEN WITH PROTECTION FACTOR

Sunscreens with sun protection factors are unsuitable for use in a tanning salon. For tanning, the skin should have been thoroughly cleaned and be dry. For optimum skin care, we recommend using our line of body-care products after tanning.

### GENERAL

- Any person that complies with the requirements laid down in the chapter "Intended use" may use the device.
- Never exceed your personal minimum erythema dose (MED). Follow the prescribed exposure times.
- If reddening of the skin (erythema) occurs hours after tanning, temporarily stop tanning. After a week the tanning can be resumed at the beginning of the tanning table.
- If unexpected effects (such as itching) occur within 48 hours after the first tanning session, you should consult a physician before tanning again.
- Once final tanning has been achieved, additional tanning is only possible by greatly exceeding the permissible tanning times. It is essential to avoid this.
- UV-radiation from the sun or from UV-devices can cause irreversible skin or eye dama. These biologi-

cal effects depend on the type and amount of radiation as well as on the individual sensitivity of the skin.

- In cases of pronounced individual sensitivity or allergic reactions to UV-radiation, a physician should be consulted before beginning tanning.
- After excessive exposure to radiation, the skin may exhibit sunburn. Excessively repeated exposure to UV radiation of sunlight or UV appliances can result in premature ageing of the skin and in a higher risk of skin cancer.
- The unprotected eye can suffer from surface inflammation, and in certain cases, e.g. after a cataract operation, excessive radiation can damage the retina. After many repeated sessions, a cataract may form.
- Seek medical advice if persistent swellings or sores develop on the skin or if pigmented moles change in appearance.

### FOR EACH TANNING SESSION

- Always wear the supplied protective goggles. Contact lenses or sunglasses are no substitute for the protective goggles!
- Remove cosmetics before tanning and do not use any sunscreen, or products that accelerate tanning.
- Allow for at least 48 hours to pass between sessions.
- After a tanning session in a studio, do not take another sunbath out of doors on the same day.
- Protect sensitive areas, such as scars, tattoos, and genitalia, from radiation.

## Tanning times

Please refer to the following tables for learning the individually applicable tanning times that depend on the skin type. For the precise definition of the skin types, please refer to the supplied skin-type table. If the tanning session sequence is interrupted for 4 weeks or more, you will have to start with the first session again.

The interval between two tanning sessions must be at least 48 hours.

The times mentioned in the tanning schedules only apply on the condition that tubes are replaced according to the maintenance intervals stipulated in the section dealing with maintenance.

EU TANNING SCHEDULE - according to UV-Type III and 0,3W/m<sup>2</sup> in compliance with EN 60335-2-27

	Skin type					
	I	II	III	IV	V	VI
1. Session	6 min	6 min	6 min	6 min	6 min	6 min
2. Session	6 min	7 min	7 min	8 min	10 min	11 min
3. Session	7 min	7 min	9 min	10 min	14 min	17 min
4. Session	7 min	8 min	10 min	12 min	19 min	22 min
5. Session	8 min	9 min	12 min	14 min	23 min	28 min
6. Session	9 min	10 min	13 min	16 min	27 min	33 min
7. Session	9 min	11 min	15 min	19 min	32 min	39 min
8. Session	10 min	12 min	16 min	21 min	36 min	44 min
9. Session	10 min	13 min	18 min	23 min	40 min	50 min
10. Session	11 min	14 min	19 min	25 min	44 min	> 55 min
Max. number of tanning sessions per year	87	68	50	38	22	17

# Operation in tanning mode

**⚠ DANGER!**

**Excessive dose of UV radiation**

If the tanning session is prolonged excessively, the skin and the eyes will be injured severely.

- Never operate the solarium with a defective timer.
- Comply with the tanning times given in the tanning schedule.

The tanning mode starts automatically after the warm-up time specified in the timer has elapsed. During the warm-up time, the tanning session can be started manually by pressing the START button.

## Displays in tanning mode

The following section shows the display and names its operating elements available in the tanning mode. Which of the operating elements are actually available on your Tower depends both on the optional features selected for your tanning system and on the settings made in the service menu.

DISPLAY 1

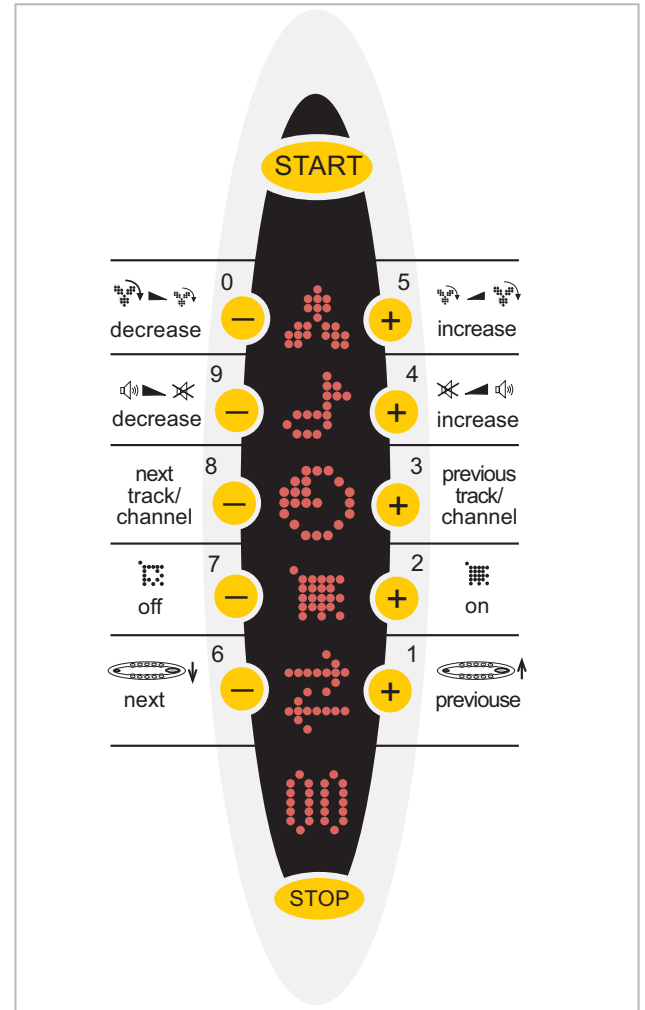

	Body fan
	Volume
	Next track (for MP3) Channel selection (for studio music)
	aquaCool: on/off/empty
	Back to previous/forward to next display
	Display of session time and of change in volume and fan power



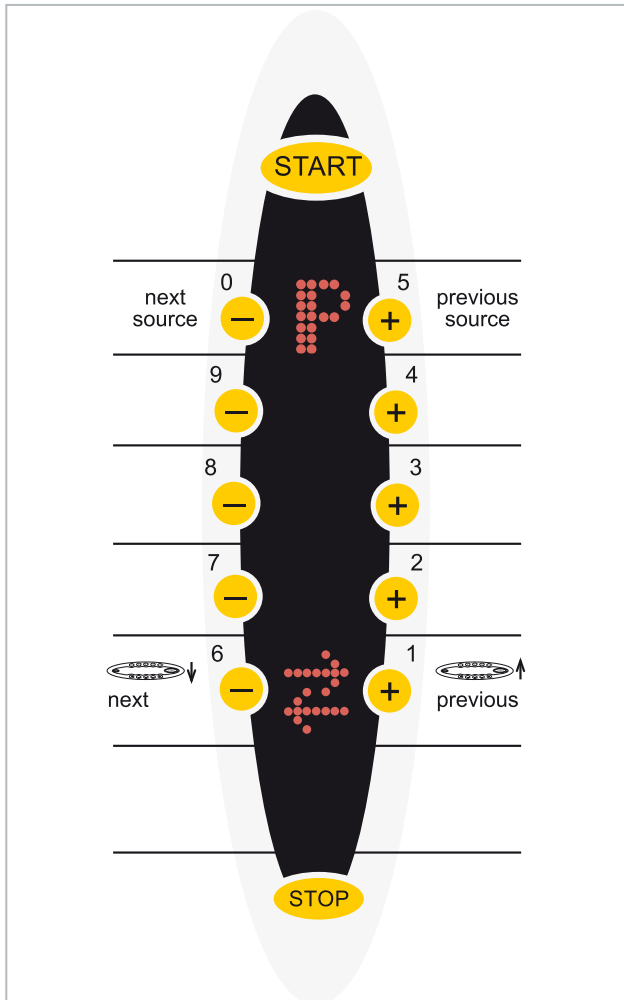

DISPLAY 2



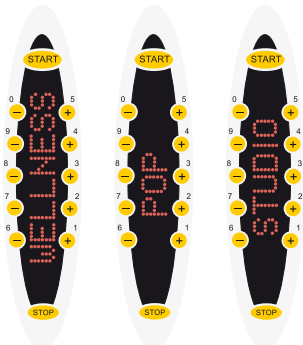

Display of the selected source



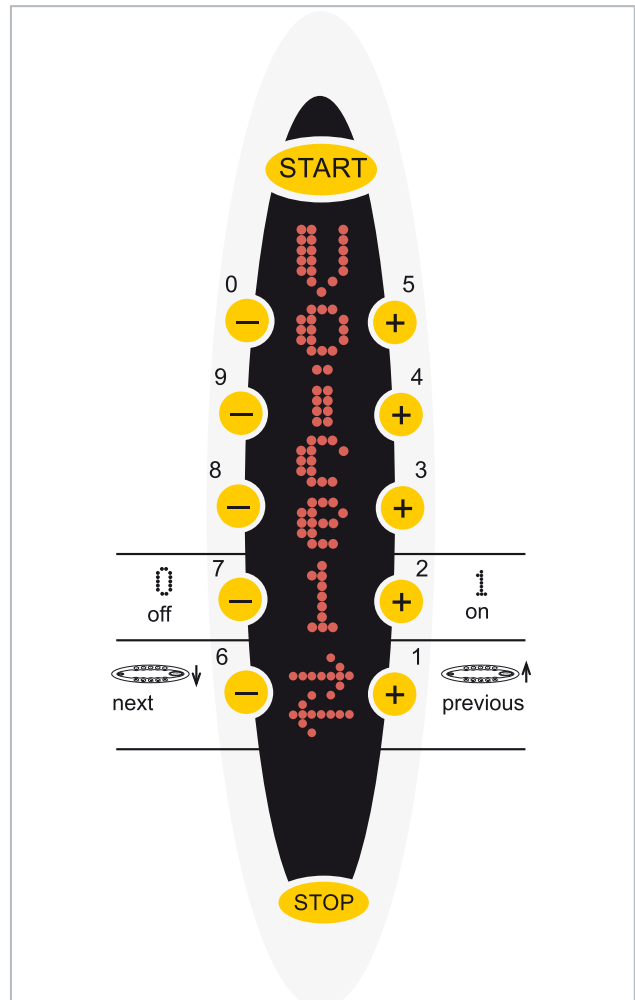

	<p>P = "Program". Switching over between the audio sources configured in the service menu (<i>Wellness</i>, <i>Pop</i> and <i>Studio</i>). The selected source is displayed briefly while changing over.</p>
	<p>Back to previous/forward to next display</p>

DISPLAY 3



	<p>megaVoice: on/off</p>
	<p>Back to previous/forward to next display</p>

## Assuming the tanning position and starting / stopping the tanning session

	 <b>WARNING</b>
	<p><b>UV radiation</b></p> <p>UV radiation can cause skin and eye injuries.</p> <ul style="list-style-type: none"> <li>• Observe the tanning instructions.</li> <li>• If in doubt, refrain from tanning.</li> </ul>

### ASSUMING THE TANNING POSITION

The door must be kept closed during the tanning session in order to ensure the proper functioning of the ventilation system. Persons with long hair need to wear a hair net during the session.

1. Close the door and place yourself in the middle of the Tower cabin. Make sure that you are positioned at an equal distance between your body and the surrounding sunlamps.
2. Put on the protective goggles.

### STARTING

To start the system during the warm-up time, press the **START** button. After the set warm-up time has elapsed, the tanning session will commence automatically.

### STOPPING

Keep the **STOP** button pressed for at least two seconds. As an acknowledgement, you will hear a sound signal, and the session-time display starts flashing. The session is discontinued but the time will continue to be counted. The tanning session can be continued by pressing the **START** button if the available session time has not elapsed yet.

After the time given by the timer has elapsed, the session is terminated automatically, and the fan will run on for three minutes.

## Adjusting the body fan

	<p>20-99 %, off ("off" only with central exhaust- air module and only within the initial 7 operating minutes)</p>
---	---

As the body fan is also used for cooling down the tanning unit, it is not always possible to decrease the power down to 20 %. The minimum possible power level depends on the temperature of the unit.

- To decrease the fan power, press the minus button.
- To increase the fan power, press the plus button.
- To turn off the fan, reduce the power to 20 %, then press the minus button again and keep it pressed for 0.5 seconds. The fan is turned off after a delay.

## Adjusting the volume (optional feature)

This section is only applicable to units with an audio option.

	<p>0-99 %</p> <p>While the volume is being adjusted, the value is displayed to the right of the <b>STOP</b> button.</p>
---	---

The initial value is set via **AUDIO/VOL.HOT** and **VOL.COOL** in the service menu.

- To decrease the volume, press the minus button.
- To increase the volume, press the plus button.
- To turn off the sound, use the minus button to set the value to 0.

## Selecting the audio source and track (optional feature)

This section is only applicable to units with an audio option.

### SELECTING AN AUDIO SOURCE



The audio source (*Wellness, Pop or Studio Music*) is selected via "P" (= program) in display 2. However, a selection is possible only on the condition that at least two sources are available and have been configured in

the service menu.

After the start of the tanning program, the audio source defined as the default one in the service menu is selected. If *Wellness* or *Pop* has been selected as the default audio source, one title is randomly chosen from the directory and played after the unit has been turned on. After that, the following tracks are played one after the other.

	Indicates that a selection of various audio sources is available. When making your choice, the selected source is being displayed for a short time.
WELLNESS	Indicates that you have selected the <i>Wellness</i> tracks.
POP	Indicates that you have selected the <i>Pop</i> tracks.
STUDIO	Indicates that you have selected the external audio source.
The available audio sources are defined via AUDIO/WPS in the service menu. The default source is determined via AUDIO/PRESEL in the service menu.	

In order to choose an audio source, proceed as follows:

- Press  to invoke display 2.
- Press the plus or minus button of the  display as often as necessary until the desired audio source is displayed.

#### SELECTING THE AUDIO TRACK AND CHANNEL



When you switch over from *Wellness* or *Pop* to *Studio Music*, the player remembers the title being played at that time and restarts playing it after switching back.

	This symbol means “next track” in <i>Wellness</i> or <i>Pop</i> mode and “next channel” with the studio music option.
---	---

In order to choose a track or a channel, proceed as follows:

- Press the plus button above the symbol to jump to the following title/channel.
- Press the minus button below the symbol to jump to the previous title/channel.

### aquaCool (optional feature)

	On
	Off
	aquaCool canister is empty
The initial value ( <i>on</i> or <i>off</i> ) is set via AAC/AQUA/AQUA in the service menu. The cycle time is defined via the menu item AAC/AQUA/Cycle in the service menu.	



This section only applies to tanning units equipped with aquaCool. Here you can switch the aquaCool spraying on (plus button, symbol flashing) or off (minus button, symbol not flashing). aquaCool is started in accordance with the settings made in the service menu. An ongoing spraying process cannot be stopped.

- If the system is running short of aquaCool liquid, the message “Aqua low” is displayed between sessions. After the first message, there is sufficient aquaCool left for approx. 2.5 hours of operation with aquaCool (depending on the preset cycle time; 2.5 operating hours if cycle time = 1 min).
- If the system has run out of aquaCool liquid, the message “Aqua 0 %” appears and the symbol is crossed out. If you wish to continue to operate the unit without aquaCool, you can switch off the messages and the symbol. To do so, go to the service menu and deactivate the submenu AQ of PIN II.

### megaVoice on/off (optional feature)

VOICE1	On
VOICE0	Off
The initial value ( <i>on</i> or <i>off</i> ) is set via BACKTAN/PRESEL in the service menu.	

To switch megaVoice on or off, proceed as follows:

- Press  to invoke display 3.
- Press the plus or minus button above or below /  
 to set the desired value.

# Standby/service mode

In standby mode, you can turn the decorative lighting of the Tower on and off. In service mode, settings for operation in tanning mode are made, and certain values concerning the operation of the unit can be displayed.

## Turning the decorative lighting on and off

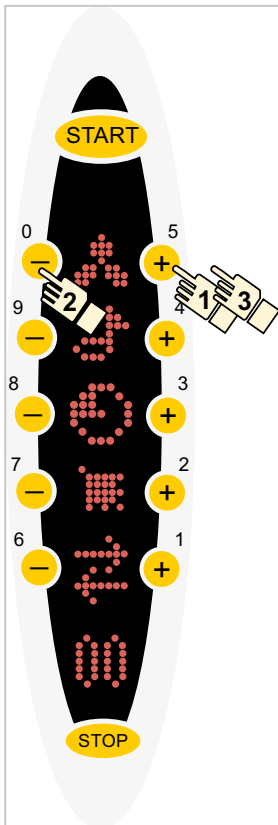

Press the plus and minus buttons in the indicated order to turn the decorative lighting on or off.

In addition to this manual procedure, you can set a timer in the service menu to have two independent switch-on and switch-off times available.

## Invoking the service menu

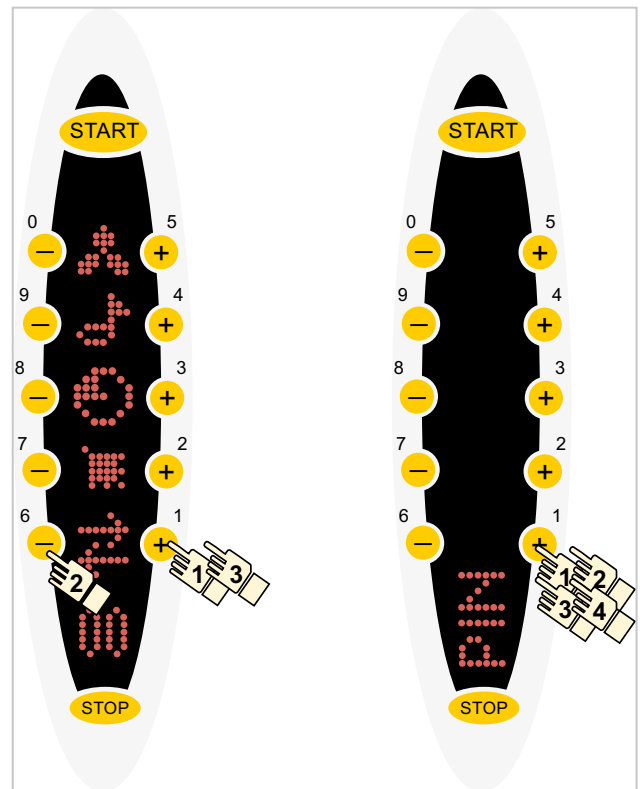

The service menu can only be invoked from the standby mode. Press the plus and minus buttons in the order indicated above in order to open the service menu. Some of the menu items can only be opened after having entered another PIN (PIN II). Please get in touch with the KBL service organisation to obtain PIN II.

## Overview: KBL5 service menu

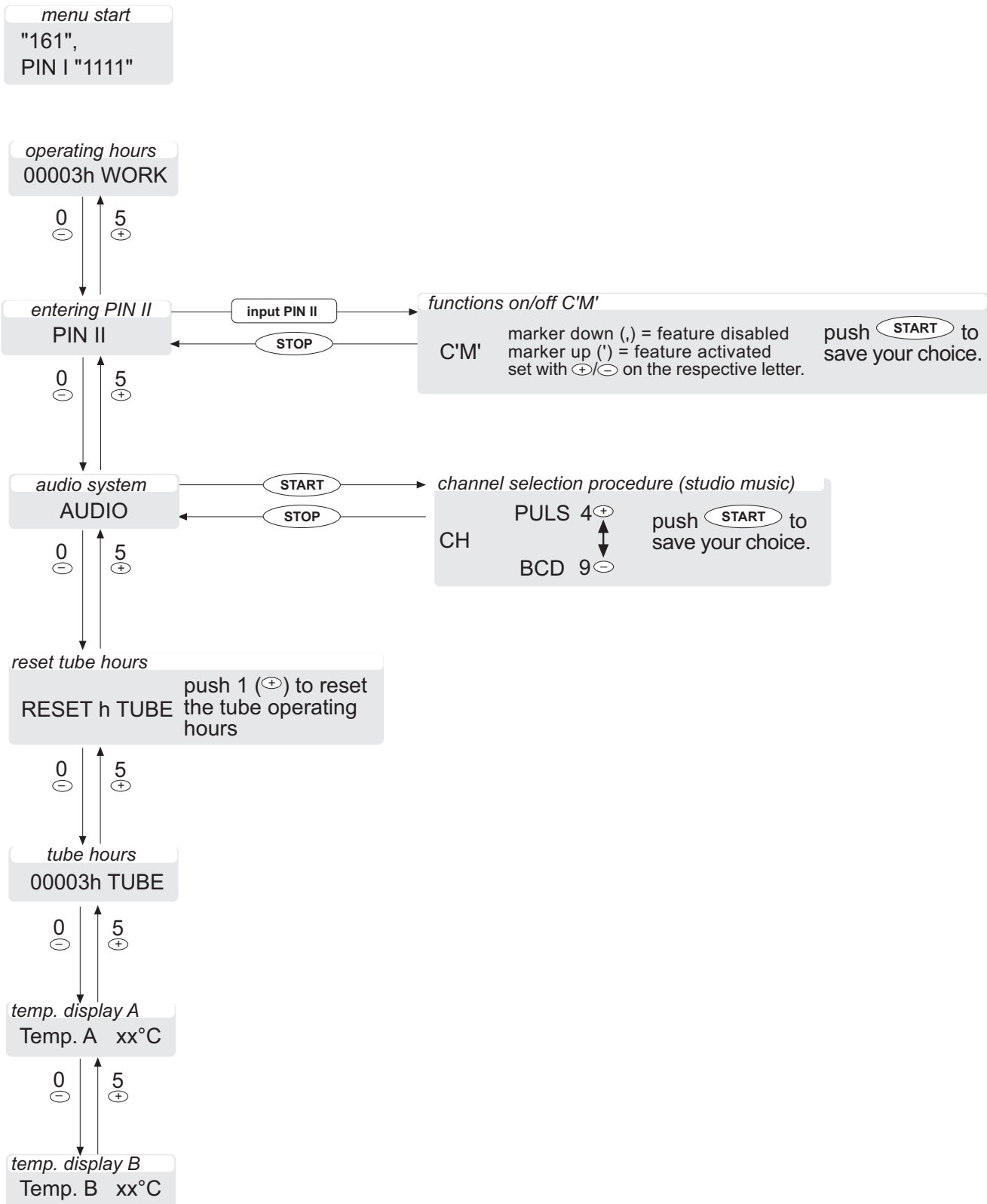



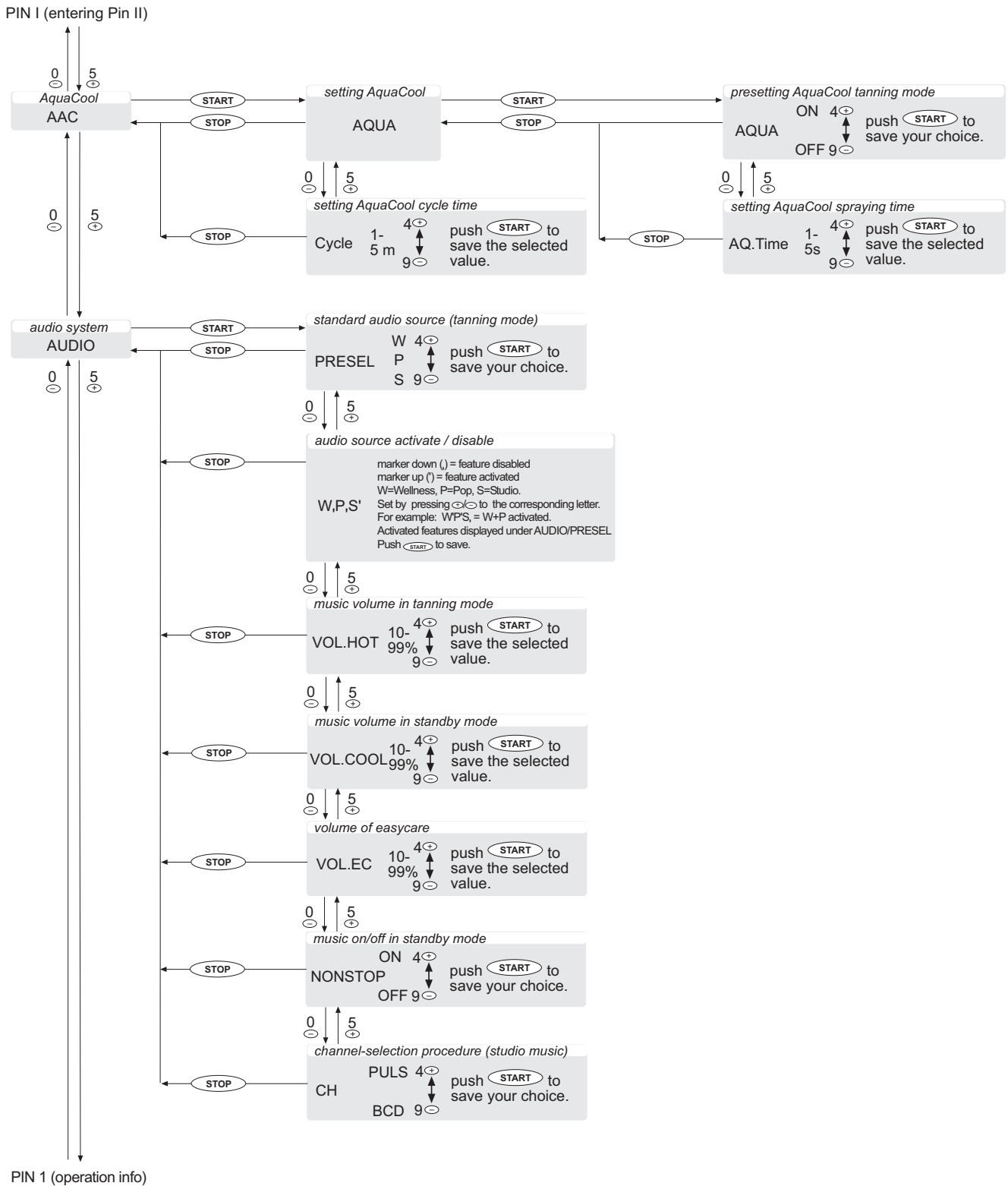

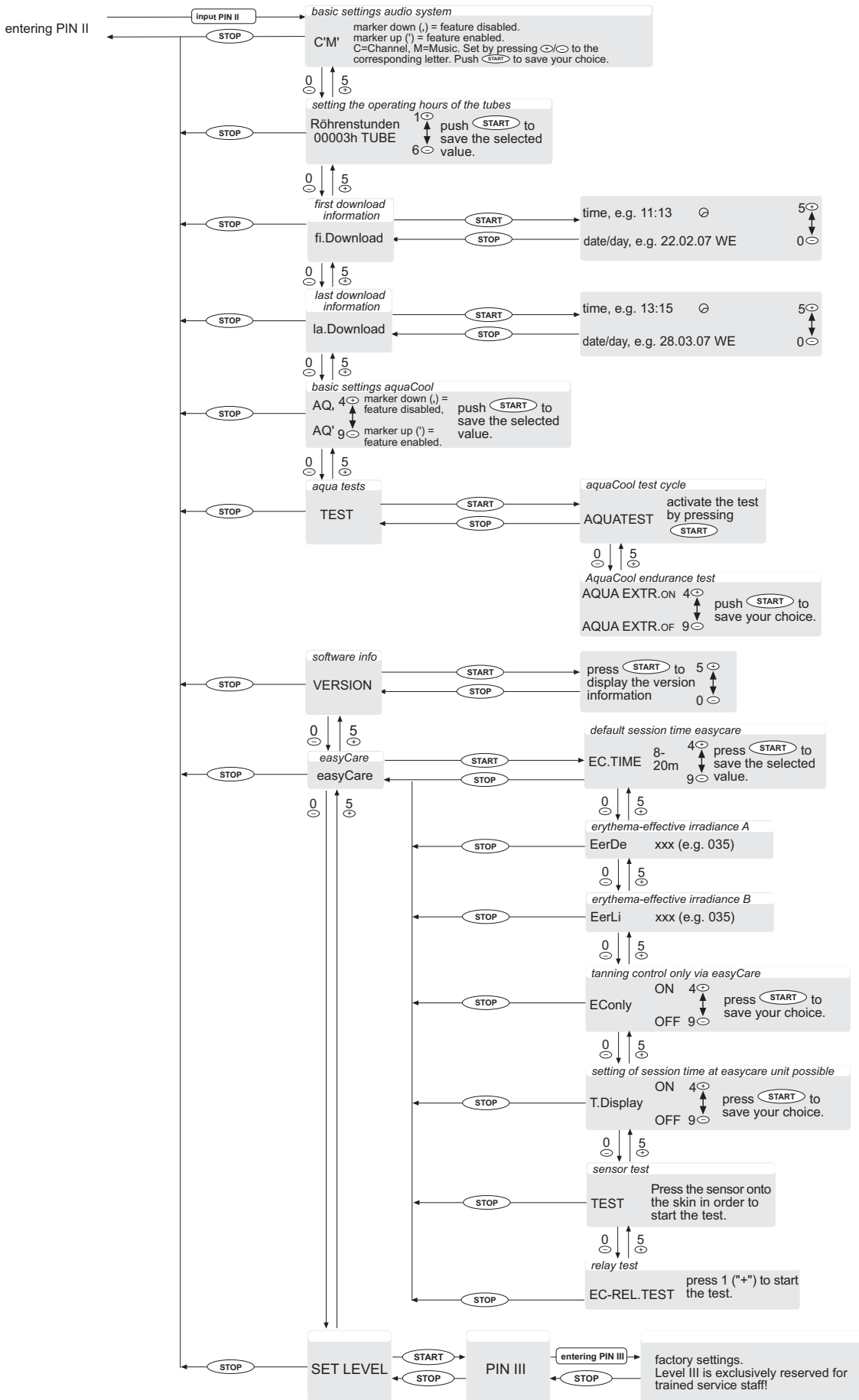



KBL5 and KBL4 processors use different software variants! The KBL5 menu only contains a subset of the setting options available in the KBL4 menu. The order of the following information refers to the KBL4 menu. KBL4 menu items are labelled ④. Items pertaining to the KBL5 menu are additionally marked ⑤.

## Settings on service level I

### Information about operation ④

Select the menu item `Operation-Info` to display the working hours of the tanning system (`WORK`), the operating hours of the tubes (`TUBE`) as well as temperature information.

### Displaying the operating hours of the solarium ④⑤

The menu item `xxxxxh WORK` is used to display the operating hours of the tanning unit.

1. Invoke the display of the operating hours (`xxxxxh WORK`) by pressing 0 (minus button) or 5 (plus button).
2. Press `STOP` to exit the menu.

### Displaying the operating hours of the tubes ④⑤

The menu item `xxxxxh TUBE` is used to display the operating hours of the solarium's tubes.

1. Invoke the display of the operating hours of the tubes (`xxxxxh TUBE`) by pressing 0 (minus button) or 5 (plus button).
2. Press `STOP` to exit the menu.

### Temperature display A/B ④⑤

The temperature displays A and B indicate the measured values of internal sensors.

Press 0 (minus button) or 5 (plus button) to invoke the displays `Temp.A` and `Temp.B`.

### Resetting the operating hours of the tubes (KBL4/KBL5)

④⑤

Use the menu item `CPI RESET (KBL4)` to reset the operating hours of the tubes to zero for inductive and CPI-equipped units. These tube hours must be reset after each replacement of tubes.

1. Invoke the `PIN II` menu and enter the PIN.
2. Press 5 (plus button) or 0 (minus button) to select `CPI`.
3. Press `START` to open `CPI RESET`.
4. Keep 1 (plus button) pressed as long as necessary to set the hours to zero.
5. Press `START` to save the settings, then exit the menu using the `STOP` button.

Use the menu item `RESET h TUBE (KBL5)` to reset the operating hours of the tubes to zero. These tube hours must be reset after each replacement of tubes.

1. Press 5 (plus button) or 0 (minus button) to select `RESET h TUBE`.
2. Keep 1 (plus button) pressed as long as necessary to set the hours to zero.
3. Press `START` to save the settings, then exit the menu using the `STOP` button.

### Setting the timer function of the decorative lighting ④

The menu item `TIME/DATE` allows you to enter two pairs of times per day at which the decorative lighting is automatically switched on and off (e.g. Monday at 10:00 h on, at 12:00 h off, at 13.00 h on again, and

at 22:00 h off, Tuesday at 11:00 h on, at 22:00 h off, etc.). If a switching time is not required, it can be deleted by pressing 1.

1. Invoke the **TIMER** menu.
2. Select the days of the week with **START** and then press 5 (plus button) or 0 (minus button) to set the desired day.
3. Press **START** to invoke **AON** and set the desired time using the plus and minus buttons 2, 3, 7, 8. Press **START**. Proceed in the same way for **AOFF**, **BOH** and **BOF**.
4. Press **STOP** to leave the menu.

## Setting date and time ④

The current time and date are set within the menu item **TIME/DATE**. This information is required for the proper execution of the timer function for the decorative lighting. Date and time are displayed for approx. 2 seconds after the unit has been turned on.

1. Invoke the **TIME/DATE** menu.
2. Choose the time setting with **START** and set the time by pressing the plus or minus buttons to the corresponding number.
3. Choose the date setting using 5 (plus button) or 0 (minus button) and set the date by pressing the plus or minus buttons to the corresponding number. The day of the week is determined automatically.
4. Save the settings using **START** and press **STOP** to exit the menu.

## Entering PIN II ④⑤

By entering your PIN II here, you will be admitted to the next service level.

(See *Settings on service level II*).

## Setting aquaCool characteristics ④

### PRESETTING TANNING MODE

Use the menu item **AAC/AQUA/AQUA** to determine whether aquaCool is started automatically with the tanning session (**AQUA ON**) or if it can be activated manually by the studio client (**AQUA OFF**).

1. Invoke the **AAC** menu.
2. Invoke the submenu by pressing **START** twice; then press 5 (plus button) or 0 (minus button) to select **AQUA**.
3. Select **AQUA ON** by pressing 4 (plus button) or **AQUA OFF** by pressing 9 (minus button).
4. Save the settings by pressing **START** and exit the menu by pressing the **STOP** button.

### SETTING THE AQUACOOL CYCLE TIME

The menu item **AAC/AQUA/Cycle** is used to set the interval between spraying cycles: between 0.5 and 5 minutes.

1. Invoke the **AAC** menu.
2. Press **START** to invoke the submenu and 5 (plus button) or 0 (minus button) to select **Cycle**.
3. Set the cycle time using 4 (plus button) or 9 (minus button) .
4. Press the **START** button to save the settings and leave the menu by pressing **STOP**.

### SETTING THE AQUACOOL SPRAYING TIME

The menu item **AAC/AQUA/AQ.Time** is used to set the duration of a spraying cycle: between 2 and 6 seconds.

1. Invoke the **AAC** menu.
2. Press the **START** button twice to invoke the submenu, then select **AQ.Time** by pressing 5 (plus button) or 0 (minus button).
3. Select the spraying time by pressing 4 (plus button) or 9 (minus button).
4. Save the settings with **START** and press **STOP** to leave the menu.

## Setting the audio music system ④⑤

### STANDARD AUDIO SOURCE ④

The menu item **AUDIO/PRESEL** is used to determine which audio source is selected as the default source when the tanning session is started. Only sources that are activated under **WPS** can be selected.

1. Invoke the **AUDIO** menu.
2. Press **START** to invoke the submenu and press 5 (plus button) or 0 (minus button) to select **WPS**.
3. Preselect the desired source by pressing 4 (plus button) or 9 (minus button).
4. Press **START** to save the settings and **STOP** to exit the menu.

### ACTIVATING/DEACTIVATING AUDIO SOURCES ④

The menu item **AUDIO/WPS** is used to determine which audio sources are to be made available to the salon client. W=Wellness, P=Pop, S=Studio Music. In the case of a top mark (apostrophe: **W'**), the corresponding source is activated while it is deactivated if a bottom mark is shown (comma: **W,**). All activated sources are listed under **AUDIO/PRESEL**.

1. Invoke the **AUDIO** menu.
2. Use **START** to invoke the submenu and 5 (plus button) or 0 (minus button) to select **PRESEL**. Set the desired value by using the plus and minus buttons to the corresponding letters.
3. Press **START** to save the settings and leave the menu by pressing **STOP**.

### MUSIC VOLUME IN TANNING MODE ④

The menu item **AUDIO/VOL.HOT** is used in order to determine the volume of the music during a tanning session. The maximum possible volume of the unit is at 100 %.

1. Invoke the **AUDIO** menu.
2. Use **START** to invoke the submenu and press 5 (plus button) or 0 (minus button) to select **VOL.HOT**.
3. Set the desired percentage by pressing 4 (plus button) or 9 (minus button).
4. Press **START** to save the settings and **STOP** to exit the menu.

### MUSIC VOLUME IN STANDBY MODE ④

Use the menu item **AUDIO/NONSTOP** to determine whether music is also played during standby operation (ON) or not (OFF).

1. Invoke the **AUDIO** menu.
2. Use **START** to invoke the submenu and 5 (plus button) or 0 (minus button) to select **NONSTOP**.
3. Set **NONSTOP ON** by pressing 4 (plus button) or **NONSTOP OFF** by pressing 9 (minus button).
4. Press **START** to save the settings, and leave the menu by pressing **STOP**.

### VOLUME OF EASYCARE ④

Select the menu item **AUDIO/VOL.EC** in order to set the volume of the easyCare unit. The maximum possible volume of this unit is 100 %.

1. Invoke the **AUDIO** menu.
2. Press **START** to open the submenu and select **VOL.EC** by pressing 5 (plus button) or 0 (minus button).
3. Set the desired percentage using 4 (plus button) or 9 (minus button).
4. Press the **START** button to save the settings and then press **STOP** to exit the menu.

### MUSIC ON/OFF IN STANDBY MODE ④

Use the menu item **AUDIO/NONSTOP** to switch the music on or off in standby mode.

1. Invoke the **AUDIO** menu.
2. Press the **START** button to invoke the submenu and then press 5 (plus button) or 0 (minus button) to select **NONSTOP**.
3. Switch the option on or off by pressing 4 (plus button) or 9 (minus button).
4. Save the settings by pressing **START**; press **STOP** to leave the menu.

### CHANNEL-SELECTION PROCEDURE ④⑤

The external channel-selection procedure is defined via the menu item **AUDIO/CH**.

1. Invoke the **AUDIO** menu.
2. Invoke the submenu by pressing **START** and select **CH** by pressing 5 (plus button) or 0 (minus button).
3. Select **PULS** by pressing 4 (plus button) or **BCD** by pressing 9 (minus button).
4. Press the **START** button to save the settings and leave the menu by pressing **STOP**.

## Settings on service level II

### Basic settings audio system ④⑤

The menu item PIN II/CM is used to make basic settings for the audio system.

1. Invoke the PIN II menu and enter the PIN.
2. Set the desired value by pressing the plus and minus buttons to the corresponding letter.
3. Save the settings by pressing START, press STOP to leave the menu.

C (Channel) is deactivated if only external channel selection with exactly one channel is available for the unit. The channel-selection symbol is not displayed. M (Music) is deactivated in case there is no audio system available. No symbols regarding the audio system are displayed.

### Setting the operating hours of the tubes ④

Go to the menu item PIN II/CM if you want to enter the operating hours of the tubes.

1. Invoke the PIN II menu and enter the PIN.
2. Press START to invoke RÖHRENSTUNDEN EINSTELLEN (SET OPERATING HOURS OF TUBES).
3. Enter the desired value by pressing 5 (plus button) and 0 (minus button).
4. Save the settings by pressing START and exit the menu using the STOP button.

### Download information ④

The menu items PIN II/La.Download and PIN II/fi.Download indicate time and date of the latest (La.Download) or of the first (fi.Download) software download.

1. Invoke the PIN II menu and enter the PIN.
2. Select La.Download or fi.Download by pressing 5 (plus button) or 0 (minus button).
3. Press the START button to display the

corresponding information.

### Basic settings aquaCool (activating/deactivating) ④

The menu item PIN II/AQ is used to activate the aquaCool function (top mark) or to deactivate it (bottom mark). If the function has been deactivated, the aquaCool symbol is not displayed, and the studio customer cannot activate aquaCool.

1. Invoke the PIN II menu and enter the PIN.
2. Select AQ using 5 (plus button) or 0 (minus button).
3. Activate the function by pressing 4 (plus button) and deactivate it by pressing 9 (minus button).
4. Save the settings by pressing START and exit the menu by pressing the STOP button.

### aquaCool tests ④

#### AQUACOOOL TEST CYCLE

The menu item PIN II/TEST/AQUATEST allows for starting a spraying cycle to test the spraying function.

1. Invoke the PIN II menu and enter the PIN.
2. Press 5 (plus button) or 0 (minus button) to select TEST.
3. Press START to select the AQUATEST submenu. Activate the test by pressing START.

#### AQUACOOOL ENDURANCE TEST

Under the menu item PIN II/TEST/AQUA EXTR. you can determine whether an aquaCool endurance test is to be started with the subsequent tanning session. This test has a cycle time of 5 minutes and covers the whole of the tanning time.

1. Invoke the PIN II menu and enter the PIN.
2. Press 5 (plus button) or 0 (minus button) to select TEST.
3. Press the START button to invoke the submenu and 5 (plus button) or 0 (minus button) to select

AQUA EXTR.

4. Select AQUA EXTR. ON by pressing 4 (plus button) or AQUA EXTR. OFF by pressing 9 (minus button).

## Querying software information

④

Select the menu item PIN II/VERSION to display the name and number of the installed software version. This information is also displayed for approx. 2 seconds after the unit has been switched on.

1. Invoke the PIN II menu and enter the PIN.
2. Press 5 (plus button) or 0 (minus button) to select VERSION.
3. Press START to display the version information.

## Setting the easyCare unit ④

The menu items concerning easyCare are only displayed if the tanning system is equipped with an easyCare unit. For information other than the menu setting, please refer to the easyCare manual.

### DEFAULT SESSION TIME EASYCARE

The session time set here is used whenever easyCare is activated without allowing for making settings via the easyCare display itself (T.Display = OFF).

1. Invoke the PIN II menu.
2. Press 5 (plus button) or 0 (minus button) to select easyCare.
3. Open the submenu by pressing START and then select EC.TIME using 5 (plus button) or 0 (minus button).
4. Enter a duration of time between 8 and 20 minutes.
5. Press START to save the settings and STOP to exit the menu.

### DISPLAY OF THE ERYTHEMA-EFFECTIVE IRRADIANCE

This value is given for information only.

1. Invoke the PIN II menu.
2. Press 5 (plus button) or 0 (minus button) to select easyCare.
3. Press START to open the submenu and select EerLi or EerDe using 5 (plus button) or 0 (minus button).
4. Exit the menu by pressing STOP.

### TANNING CONTROL ONLY VIA EASYCARE

You can determine whether easyCare can be deactivated or not.

1. Invoke the PIN II menu.
2. Select easyCare by pressing 5 (plus button) or 0 (minus button).
3. Press the START button to open the submenu and select E.Conly using 5 (plus) or 0 (minus button).
4. Select the desired setting by pressing 4 (plus button) or 9 (minus button). ON=easyCare cannot be deactivated, OFF=easyCare can be deactivated.
5. Press START to save the settings and leave the menu by pressing STOP.

### SETTING OF SESSION TIME AT EASYCARE UNIT POSSIBLE

Here you can determine whether it will be possible to set the session time via the easyCare display.

1. Invoke the PIN II menu.
2. Select easyCare by pressing 5 (plus button) or 0 (minus button).
3. Press START to open the submenu and select T.Display by pressing 5 (plus button) or 0 (minus button).
4. Select the desired setting by pressing 4 (plus button) or 9 (minus button). ON=setting via display possible, OFF=setting via display impossible.
5. Save the settings by pressing START and exit the menu via STOP.

### SENSOR TEST

The sensor test is carried out to check whether the sensor is functional.

1. Invoke the PIN II menu.

2. Select **easyCare** by pressing 5 (plus button) or 0 (minus button).
3. Press **START** to go to the submenu and select **TEST** by pressing 5 (plus button) or 0 (minus button).
4. Press the sensor onto the skin in order to start the test.
5. Press **STOP** to leave the menu.

#### RELAY TEST

The relay test is used to test the functionality of any possible combination of power levels of tubes and sunlamps. In order to be able to carry out this test, there must be an incoming timer signal.

1. Invoke the **PIN II** menu.
2. Select **easyCare** by pressing 5 (plus button) or 0 (minus button).
3. Open the submenu by pressing **START** and select **EC-REL. TEST** using 5 (plus button) or 0 (minus button).
4. Press 1 (plus button) to start the test.
5. Press the **STOP** button to exit the menu.

### Entering PIN III ④

If you enter your PIN III here, you will access the next service level.

Level III is exclusively reserved for trained service staff!

# Maintenance and cleaning

Regular maintenance is required for the safe operation of the tanning unit and must be documented. Cleaning must be performed when necessary.

**DANGER!**

**Live parts**

Risk of fatal injury due to electric shock when touching live parts. Disconnect from mains according to **DIN VDE 0105**.

## Instructions for cleaning and care

### GENERAL

- Before starting to clean the unit, take off any rings, bracelets, watches, etc. that you might be wearing in order to avoid scratching the surfaces.
- Cleaning fluid must not run into the appliance.

### TUBES

- To preserve the tanning power, we recommend cleaning the tubes with warm water and a chamois after approx. 200 hours of operation.

### ACRYLIC PANES, GRAB HANDLES AND DOOR HANDLES

- If possible, use the special cleaning and disinfectant agent “megaClean” supplied by KBL for cleaning the acrylic parts and handles, and dilute it in water at a ratio of 1:13.

### VARNISHED AND PLASTIC PARTS

- Use a damp soapy cloth to clean the varnished and plastic surfaces.
- Do not clean the large plastic parts with a dry cloth. This might scratch the surfaces!

### CHROMIUM-PLATED PARTS/MIRROR PLATE OF FLOOR

- Only clean with a damp chamois and a cleaning agent for acrylic plastic (antistatic). Apply the cleaning agent onto the chamois and not directly onto the mirror surface.

### CLEANING AGENTS

- The surfaces and the acrylic panes must not be cleaned with concentrated disinfectants or solvents or other liquids that contain alcohol!

## Maintenance intervals

Component/ wearing part	Cleaning/care	Replacement
Tubes and starters, inductive units	Tubes after approx. 200 operating hours	After 650 operating hours
Electronic starters, inductive units	/	Recommended after 5 years.
Tubes, CPI-equipped units	Tubes after approx. 200 operating hours	Typical value after about 1100 operating hours. For further information see data sheet.
Acrylic panes	When necessary	When necessary
aquaCool nozzles	When necessary	After approx. 1000 hours



## Removing and installing the acrylic panes

### DISMANTLING

- Undo the three hexagon socket head screws (Allen screws) of the rear side covering strip in order to remove the panes.

Figure 33.1

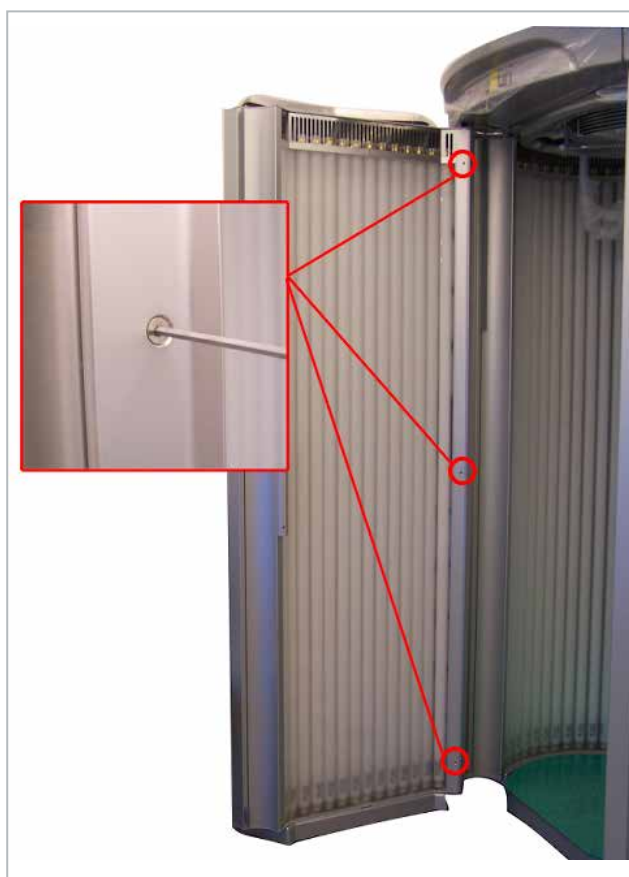

- Fold the covering strip to the left-hand side and remove it by pulling towards the front.

Figure 33.2



- If your Tower is equipped with a central exhaust-air module, also undo the screw that is centrally located at the top edge of the door pane.

Figure 33.3





- Lift the panes out of the guide rails and keep them in a safe place. Attention! When removing the rear pane, disconnect the cable of the operating element.

Figure

34.1

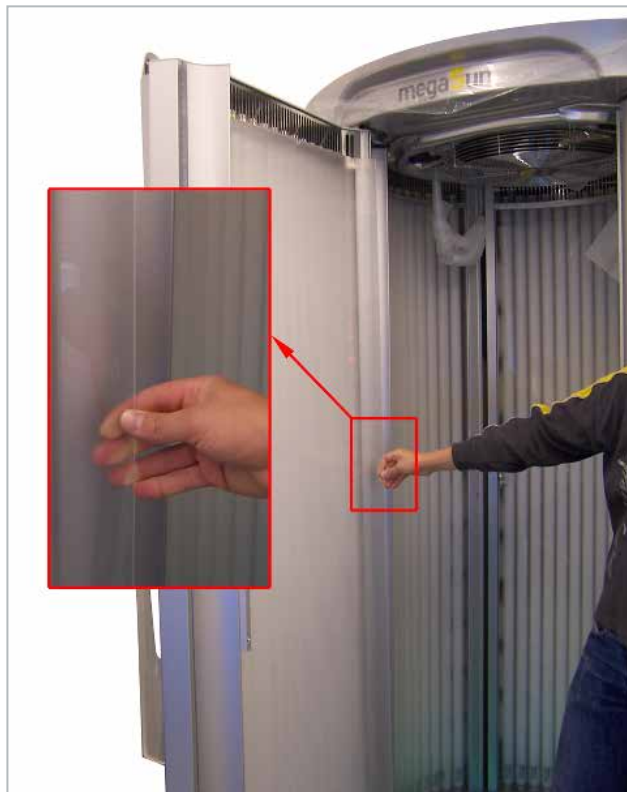

#### INSTALLATION

After the pane and, if necessary, the tubes, have been cleaned, insert the pane into the guide rails again and close the side covering strip.

## Cleaning and replacing the tubes

By regularly cleaning the tubes (see Instructions for cleaning and care), you can help to preserve their tanning power.

When replacing the tubes, you must also replace the starters. Replace tubes and starters only with ones of the same type.

When installing the tubes, make sure that the inscription on the tubes is visible, otherwise, there will be no tanning effect.

If your tanning unit is equipped with CPI, always

perform a reset after each replacement of tubes!

Also reset the counter of the operating hours of the tubes after each tube replacement.

#### REMOVING AND INSTALLING THE TUBES

1. Remove the side panes.
2. Remove the tubes by turning each tube a quarter to the right or to the left and then pulling it out. Remove the tubes from the lower sockets first.
3. Use warm water and a chamois to clean the tubes. Do not use any aggressive or alcohol-containing cleansing agents.
4. Before replacing the tubes, replace the starters first.
5. Then insert the tubes. Make sure that the inscription on the tubes is visible, otherwise, there will be no tanning effect.
6. Assembly is performed in reverse order.
7. Reset the operating hours counter in the service menu.

<b>⚠ WARNING!</b>	
	<b>NOTE FOR MODEL T230</b>
	As the T230 is operated with electronic starters, please note the following: <b>After having switched off the tubes, wait at least one minute before switching them on again, as otherwise the electronic starters may get destroyed!</b>

## Replacing the light fittings

### DECORATIVE LIGHTING OF THE DOOR

For the purpose of decorative lighting, there is an energy-saving lamp integrated in the door. If defective, replace this lamp as follows:

- Remove the acrylic pane of the door as described in the chapter “Removing and installing the acrylic panes” and remove the four central tubes.

Figure 35.2



- Then loosen the four screws of the base plate and carefully remove the plate. (The tube is installed on its rear side.)
- Replace the tube by simply pulling it off its holder and by pushing the new one into the holder (figure 37.1).

Figure 37.1

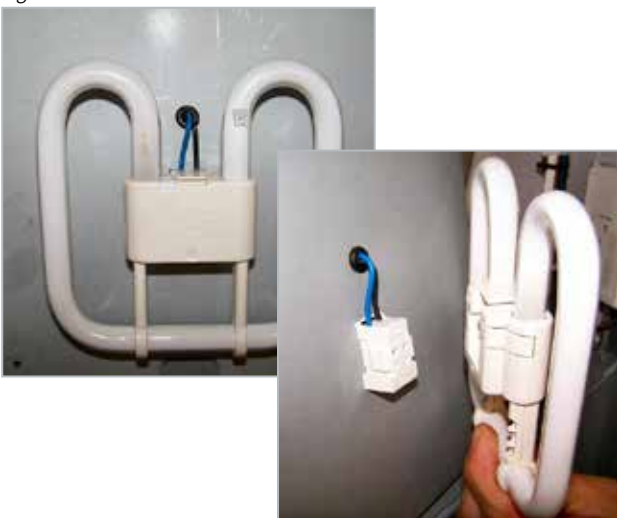

- Assembly is carried out in reverse order.

### INTERIOR LIGHTING

The interior lighting of the Tower, a high-power LED, is located on the ceiling.

If defective, replace the LED as follows:

- Fasten the acrylic-plastic facing in order to prevent it from dropping down into the Tower cabin (2nd person or adhesive tape)!

Figure 37.2

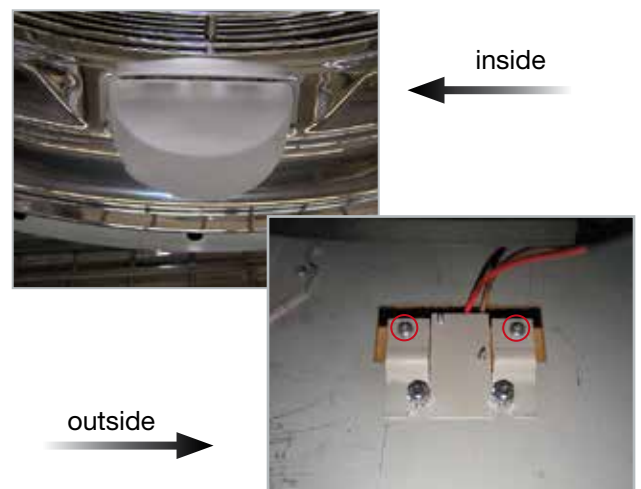

- Remove the two cross-recess head screws (Phillips screws) that hold the facing from the outside (circles).
- Undo the two hexagon head screws (Allen screws, M6) and remove the LED including cooling plate from the recess.
- Disconnect the cable.

Figure 37.3



- Proceed in reverse order to install the new LED.

## Changing the SD card in the MP3 player

- Remove the acrylic pane of the rear wall, as described in the chapter “Removing and installing the acrylic panes”. Make absolutely sure that you disconnect the patch cable of the operating element!
- Remove eight tubes, from right to left, so that the right-hand part of the covering plate becomes freely accessible.

Figure 37.4



Figure 38.1



- Remove the right-hand covering plate. To do so, undo the four screws on the left-hand side of the plate and pull it upwards out of its anchoring.



- Behind the cover, there are two MP3 players. Remove the SD card from the right-hand (music) MP3 player by pushing the card slightly into the player and by then pulling it out.

Figure 38.2

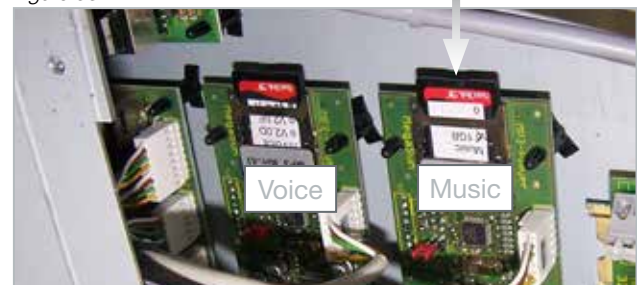



Now you can copy new music onto the SD card. Read the following chapter “Recording to an SD card” beforehand.

**Installation:**

- Slide the SD card into the player board, fasten cover, tubes and plate.
- Restart the device. To do so, pull out the main plug and plug it in again. In this way, you make sure that the MP3 player will identify the SD card.

**Recording to an SD card**

Please refer to the chapter “Technical data” for information on supported card sizes as well as file-system and MP3 formats.

Using the SD Writer software (download from <http://www.kbl-support.de/software/software.html>), you can add or delete audio files to the SD card for music at your convenience.

These tracks are played after the corresponding source has been selected.

The number of files is limited by the storage capacity of the SD card.



**Replacing the aquaCool canister**

Proceed as explained below in order to replace the aquaCool canister:

- Open the aquaCool box. Remove the screw located on the front side in order to do so.

Figure 39.1



- Slightly lift the cover at the front and pull it out of the fastening on the rear side. Lift the cover upwards and remove it.

Figure 39.2



Figure 39.3



- Unscrew the lid with the hose connections (circle) (figure 39.3) from the canister.
- Place the hoses into a plastic bag so that they do not get dirty.
- Replace the empty canister.
- Fasten the lid with the connections on the new canister.
- Fix the cover of the box in reverse order.

	⚠ WARNING!
	<p><b>Do not use anything except aquaCool by KBL in order to avoid infections or system malfunctions!</b></p>

## Replacing the aquaCool nozzles

After 1,000 hours of operation, the aquaCool nozzles must be replaced in order to ensure that the aquaCool system functions properly.

The assembly instructions are included with your spare parts delivery.

# Error messages

Faults nos. 07, 08, 12 and 13 do not occur with the KBL/5 processor due to its equipment and processor structure.

No.	Status message KBL/4	Status message KBL/5	Status description	Remedy
01	Exhaust air, Excess temperature bimetal!	Temp. Err.	Bi-metal switch triggers.	Check the air-intake/air-discharge system and the fan. Let the tanning system cool down and acknowledge the message by pressing the START button. If the fault persists, contact your Customer Service.
02	Maximum tanning time!	max. time	Incoming enabling signal from coin-box system longer than approved, i.e. the value specified under "Maximum tanning time" (voltage remains connected).	Disconnect the Tower from the coin-box system.
03	Excess temperature sensor	> 66 °C	The sensor has measured the limit value of 66 °C.	Check the air-intake/air-discharge system and the fan. Let the tanning system cool down and acknowledge the message by pressing the START button. If the fault persists, contact your Customer Service.
04	High temperature sensor	> 62 °C	A temperature exceeding 62 °C is measured for more than 3 minutes.	Check the air-intake/air-discharge system and the fan. Let the tanning system cool down and acknowledge the message by pressing START. If the fault persists, contact your Customer Service.
05	1 temperature sensor faulty!	1 sensor f.	One temperature sensor has not been found by the control system.	Replace the temperature sensor in the door (contact your Customer Service).
06	2 temperature sensors faulty!	2 sensor f.	Both temperature sensors have not been found by the control system. Ventilation works at 100 % power.	Replace temperature sensors in the door (contact your Customer Service).
07	Aqua low		The content of the aquaCool canister is sufficient for another 750 spraying seconds (2.5 operating hours at a cycle time = 1 minute).	Replace the empty aquaCool canister with a full one. Do not replace aquaCool with any other liquid. If the canister is not empty, replace the liquid-level sensor (contact your Customer Service).
08	Bus Error		I <sup>2</sup> C bus faulty.	Contact your Customer Service.
09	Error reading measurand	measur. f.	Temperature values outside the range of 0 - 85 °C.	Replace the temperature sensor. If the fault persists, replace the 1-wire-adaptor board including bus cable (contact your Customer Service).
11	Connection 1-Wire interface faulty	1-Wire f.	No connection to 1-wire-adaptor (e.g. cable break). Bus cable or 1-wire bus adaptor defective.	Replace the bus cable. If the fault persists, replace the 1-wire bus adaptor (contact your Customer Service).
12	Aqua 0%		750 spraying seconds (2.5 operating hours at a cycle time = 1 minute) have expired.	Replace the empty aquaCool canister with a full one. Do not replace aquaCool with any other liquid. If the canister is not empty, replace the liquid-level sensor (contact your Customer Service).
13	Hardware error		Main board defective.	Replace the main board (contact your Customer Service).



# Technical data

Ambient conditions	
Protective class	IP 20
Installation site	In dry rooms (booths) with sufficient airing and ventilation <ul style="list-style-type: none"> <li>• Relative air humidity: ≤ 70 %</li> <li>• Room temperature: ≤ 30 °C</li> <li>• Minimum height of the room: 2406 mm</li> </ul>
Electrical connection values	
Mains voltage	400V / ~3N / 50Hz
Wire cross section	5 x 2.5 mm <sup>2</sup> "Ölflex"
Fuses	Automatic fuse K-type (safety cut-out), 3-pole, 3 x 25 A with residual current-operated circuit breaker (FI)
Nominal power	T200: 9800 W
Air discharge (optional feature)	
Fan	Exhaust-air socket Ø 300 -- suction power max. 2000 m <sup>3</sup> /h -- 230V / ~1N / 50Hz
Exhaust-air hose	Ø 300
Unit data megaSun Tower pureEnergy - T200	
Tubes	52x ultimate 2008 R 180W - Item no: 3230076116 Equivalence key range: 180-R-(17-23)/(1,2-1,6)
Dimensions in mm (Height x width x depth)	2326 x 1359 x 2172 (when open) 2326 x 1359 x 1224 (when closed) With central exhaust-air module -> depth plus 347
Weight	max. 526 kg without central exhaust-air unit / 562 kg with central exhaust-air unit
MP3 player	<ul style="list-style-type: none"> <li>• Supports SD cards up to 1 GB</li> <li>• Supported file system (SD card): FAT16</li> <li>• Supported MP3 files: constant and variable bit rate, 96-320 Kbit/s</li> </ul>

## Views

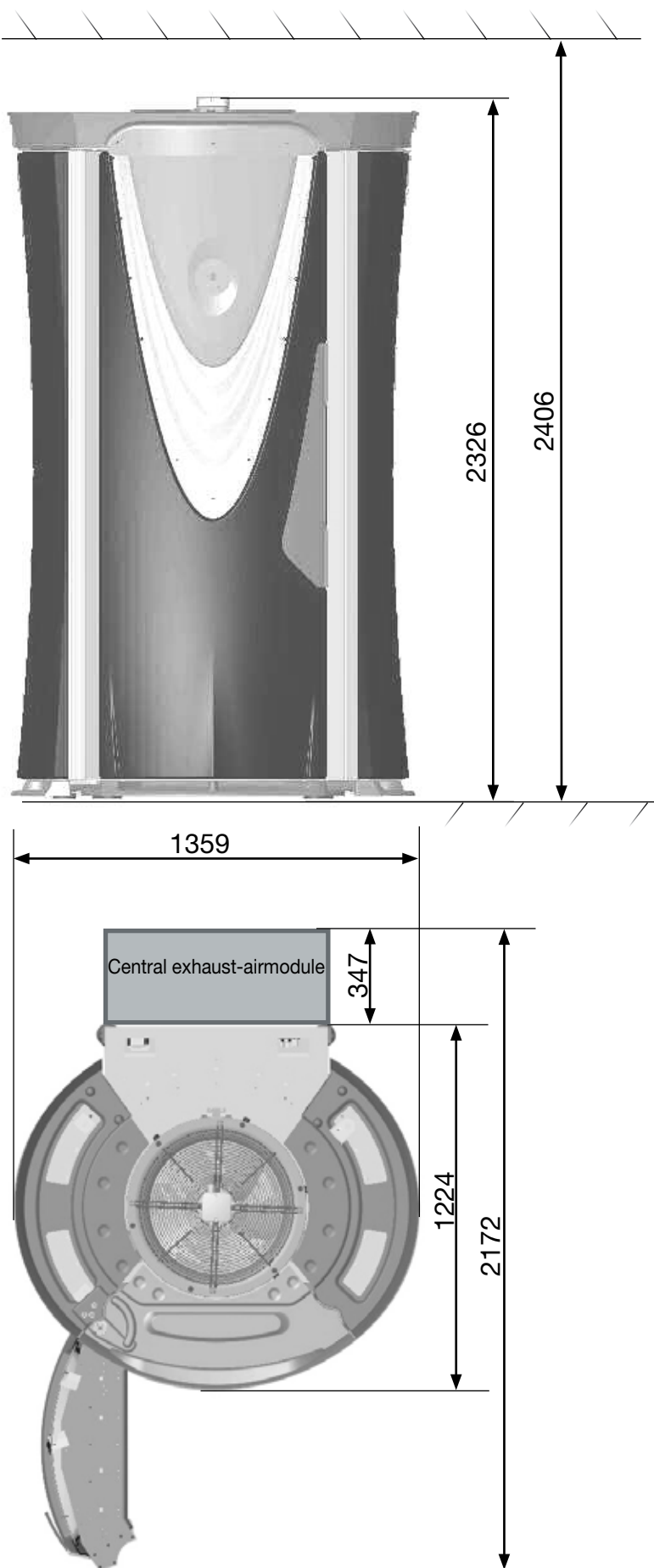



## EQUIVALENCE KEY FOR UV FLUORESCENT LAMPS

### Marking of UV fluorescent lamps according to IEC 61228

Sample coding of a lamp

**160-R-32 / 3,2**



Use of replacement tubes.

The tanning tables referring to this sunbed are only valid as long as the system is operated with the original tube set!

Ratio of the NMSC-effective  
UV irradiance  $\leq 320\text{nm}$  und  $> 320\text{nm}$   
(NMSC = Non Melanom Skin Cancer)

Erythema-effective UV irradiance in the range of  
250-400nm in  $\text{mW}/\text{m}^2$

#### Reflector types

O - For lamps without reflector

B - For lamps with reflector angles wider than  $>230^\circ$

N - For lamps with reflector angles narrower than  $<200^\circ$

R - For lamps with usual reflector angles of  $\geq 200^\circ \wedge \leq 230^\circ$

Indication of Watts (electrical power)

# Remarks



# megaSun<sup>®</sup>

by KBL

KBL AG  
Ringstraße 24-26 · 56307 Dernbach · Germany  
fon +49 (0) 26 89.94 26-0 · fax +49 (0) 26 89.94 26-66  
E-Mail [megaSun@kbl.de](mailto:megaSun@kbl.de)

[www.kbl.de](http://www.kbl.de)